



Operating and installation instructions Induction cooktops



To prevent the risk of accidents or damage to the appliance, it is **essential** to read these instructions before it is installed and used for the first time.

Contents

| | |
|---|----|
| Warning and Safety instructions | 5 |
| Caring for the environment | 16 |
| Overview | 17 |
| Cooktop..... | 17 |
| Cooking area data..... | 18 |
| Accessories supplied | 19 |
| Controls | 20 |
| Touch display | 20 |
| Symbols..... | 22 |
| Before using for the first time | 23 |
| Cleaning the cooktop for the first time..... | 23 |
| Switching on the cooktop for the first time | 23 |
| Miele@home | 24 |
| Con@ctivity..... | 27 |
| How it works | 30 |
| Noises..... | 31 |
| Power Management | 32 |
| Cookware | 33 |
| Tips on saving energy | 35 |
| Power level range | 36 |
| Operation | 37 |
| Operating principles | 37 |
| Selecting a menu option | 38 |
| Displaying the pull-down menu..... | 38 |
| Scrolling through menus | 38 |
| Exiting a menu..... | 38 |
| Changing a setting in a list | 38 |
| Pan recognition | 38 |
| Positioning cookware | 39 |
| Switching on the cooktop | 41 |
| Setting the power level..... | 41 |
| Switching off a cooking zone/the cooktop..... | 41 |
| Residual heat indicator..... | 42 |
| TempControl  | 43 |
| Setting the power level - extended power level range | 46 |
| PowerFlex Plus cooking area | 46 |

| | |
|---|----|
| Booster | 47 |
| Assistant  | 49 |
| Timer | 52 |
| Minute minder | 52 |
| Auto switch-off | 53 |
| Additional functions | 54 |
| Stop & Go | 54 |
| Recall | 54 |
| Wipe protection | 55 |
| Demonstration mode | 55 |
| Displaying cooktop data | 55 |
| Safety features | 56 |
| System lock | 56 |
| Safety switch-off | 57 |
| Overheating protection | 57 |
| Settings  | 58 |
| Cleaning and care | 60 |
| Problem solving guide | 62 |
| Messages in the display | 62 |
| Unexpected behaviour | 63 |
| Unsatisfactory results | 65 |
| General problems or technical faults | 66 |
| Optional accessories | 67 |
| Service | 68 |
| Contact in case of fault | 68 |
| Warranty | 68 |
| Installation | 69 |
| Safety instructions for installation | 69 |
| Safety distances | 70 |
| Installation notes – surface-mounted | 72 |
| Installation dimensions – Surface-mounted | 74 |
| Installation dimensions – KM 7999 FR | 74 |
| Installation dimensions – KM 7999 FL | 75 |
| Surface-mounted installation | 76 |
| Installation notes – flush-fit | 77 |

Contents

| | |
|--|----|
| Installation dimensions – Flush-fit | 78 |
| Installation dimensions – KM 7999 FL | 78 |
| Flush-fit installation | 79 |
| Electrical connection | 80 |

Warning and Safety instructions

This cooktop complies with all relevant local and national safety requirements. However, inappropriate use can lead to personal injury and damage to property.

Read the operating and installation instructions carefully before using the cooktop. They contain important information on safety, installation, use and maintenance of the appliance. This prevents both personal injury and damage to the cooktop.

In accordance with standard IEC 60335-1, Miele expressly and strongly advises that you read and follow the instructions in “Installation”, as well as in the “Warning and Safety instructions”.

Miele cannot be held liable for injury or damage caused by non-compliance with these instructions.

Keep these instructions in a safe place and pass them on to any future owner.

Warning and Safety instructions

Correct application

- ▶ This cooktop is designed for domestic use and for use in similar environments by guests in hotel or motel rooms, bed & breakfasts and other typical living quarters. This does not include common/shared facilities or commercial facilities within hotels, motels or bed & breakfasts.
- ▶ This cooktop is not suitable for outdoor use.
- ▶ It is intended only to cook food and keep it warm. Any other use is not supported by Miele and could be dangerous.
- ▶ This cooktop is not intended for use by people (including children) with reduced physical, sensory or mental capabilities or lack of experience and knowledge, unless they have been given supervision and instruction concerning its use by a person responsible for their safety. They may only use the cooktop unsupervised if they have been shown how to use it in a safe way. They must be able to recognise and understand the potential dangers of improper use.

Safety with children

- ▶ Young children must not be allowed to use this appliance.
- ▶ Older children may only use the appliance if its operation has been clearly explained to them and they are able to use it safely. They must be aware of the potential dangers caused by incorrect operation.
- ▶ Cleaning may only be carried out by older children under the supervision of an adult.
- ▶ Please supervise children in the vicinity of the cooktop and do not let them play with it.
- ▶ The cooktop gets hot when in use and remains hot for a while after being switched off. Keep children well away from the cooktop until it has cooled down and there is no danger of burning.
- ▶ Danger of burning! Do not store anything which might arouse a child's interest in storage areas above or behind the cooktop. Otherwise children could be tempted to climb onto the cooktop with the risk of burning themselves.
- ▶ Danger of burning and scalding! Turn the handles of pots and pans on the cooktop to the side or the rear so that children cannot pull them down and burn themselves.
- ▶ Danger of suffocation! Whilst playing, children may become entangled in packaging material (such as plastic wrapping) or pull it over their head with the risk of suffocation. Keep packaging material away from children.
- ▶ Activate the system lock to ensure that children cannot switch on the cooktop inadvertently.

Warning and Safety instructions

Technical safety

- ▶ Unauthorised installation, maintenance and repairs (including removal of any cover) can cause considerable danger for the user. Installation, maintenance and repairs must only be carried out by a Miele authorised technician.
- ▶ Damage to the cooktop can compromise your safety. Check the appliance for visible signs of damage. Do not use the cooktop if it is damaged.
- ▶ Temporary or permanent operation with a self-sufficient or non-mains synchronous energy supply system (e.g. isolated networks, back-up systems) is possible. A requirement for the operation is that the energy supply system complies with all current local and national requirements that apply to stand-alone, solar and/or battery systems.

The protective measures provided in the installation and in this Miele product must also be assured in their function and operation in isolated operation or in non-mains synchronous operation, or replaced with equivalent measures in the installation.
- ▶ The electrical safety of this appliance can only be guaranteed when continuity is complete between it and an effective earthing system which complies with local and national safety regulations. It is most important that this basic safety requirement is present and tested regularly and, where there is any doubt, the household wiring system should be inspected by a qualified electrician.
- ▶ Before connecting the appliance to the mains electricity supply, ensure that the connection data on the data plate (voltage and frequency) matches the mains electricity supply. This data must correspond in order to avoid the risk of damage to the appliance.
- ▶ Do not connect the cooktop to the mains electricity supply by a multi-socket adapter or extension lead. These are a fire hazard and do not guarantee the required safety of the appliance.

Warning and Safety instructions

- ▶ For safety reasons, this cooktop may only be used after it has been built in.
- ▶ This appliance must not be installed and operated in mobile installations (e.g. on a ship).
- ▶ Never open the casing of the cooktop.
Touching or tampering with electrical connections or components and mechanical parts is highly dangerous to the user and can cause operational faults.
- ▶ The manufacturer's warranty will be invalidated if the appliance is not repaired by a Miele authorised service technician.
- ▶ Faulty components must only be replaced by genuine Miele spare parts. The manufacturer can only guarantee the safety of the appliance when Miele replacement parts are used.
- ▶ The cooktop is not intended for use with an external timer switch or a remote control system.
- ▶ The cooktop must be connected to the electricity supply by a qualified electrician (see “Installation – Electrical connection”).
- ▶ If the mains connection cable is damaged, it must be replaced with a special mains connection cable by a qualified and competent electrician in order to avoid a hazard (see “Installation - Electrical connection”).

Warning and Safety instructions

- ▶ During installation, maintenance and repair work, the appliance must be disconnected from the mains electricity supply. It is only completely isolated from the electricity supply when:
 - the mains circuit breaker is switched off, or
 - it is switched off at the wall socket and the plug is withdrawn from the socket. Do not pull the mains connection cable but the mains plug to disconnect your appliance from the mains electricity supply.
- ▶ Danger of electric shock! If the ceramic surface is faulty, cracked, chipped or damaged in any way, do not use the cooktop and switch it off immediately. Disconnect the cooktop from the electricity supply. Contact Miele.
- ▶ If the cooktop is installed behind a furniture door, do not close the door while the cooktop is in operation. Heat and moisture can build up behind the closed door. This can result in damage to the cooktop, the housing unit and the floor. Do not close the door until the appliance has cooled down and the residual heat indicators have gone out.

Correct use

- ▶ The cooktop gets hot when in use and remains hot for a while after being switched off. There is a danger of burning until the residual heat indicators go out.
- ▶ Oil and fat can overheat and catch fire. Do not leave the cooktop unattended when cooking with oil and fat. If it does ignite, do not attempt to put the flames out with water. Switch off the cooktop and use a suitable fire blanket, saucepan lid, damp towel or similar to smother the flames.
- ▶ The cooking process has to be supervised. A short term cooking process has to be supervised continuously.
- ▶ Flames could set the grease filters of a rangehood on fire. Do not flambé under a rangehood.
- ▶ Spray canisters, aerosols and other inflammable substances can ignite when heated. Therefore do not store such items or substances in a drawer under the cooktop. Cutlery inserts must be heat-resistant.
- ▶ Do not heat an empty pan.
- ▶ Do not heat up food in closed containers e.g. tins or sealed jars on the cooktop, as pressure can build up in the containers, causing them to explode.
- ▶ Do not cover the cooktop, e.g. with a cooktop cover, a cloth or protective foil. The material could catch fire, shatter or melt if the cooktop is switched on by mistake or if residual heat is still present.

Warning and Safety instructions

- ▶ When the cooktop is switched on, either deliberately or by mistake, or when there is residual heat present, there is a risk of metal items placed on the cooktop heating up. Depending on the material, other items left on the appliance could also melt or catch fire. Damp pan lids might adhere to the ceramic surface and be difficult to dislodge. Do not use the cooktop as a resting place for anything else. Switch the cooktop off after use and do not rely on the pan detector.
- ▶ You could burn yourself on the hot cooktop. Protect your hands with heat-resistant pot holders or oven gloves when handling hot pots and pans. Do not let them get wet or damp, as this causes heat to transfer through the material more quickly with the risk of scalding or burning yourself.
- ▶ When using an electrical appliance, e.g. a hand-held food mixer, near the cooktop, ensure that the cable of the electrical appliance cannot come into contact with the hot cooktop. The insulation on the cable could become damaged.
- ▶ Grains of salt, sugar and sand (e.g. from cleaning vegetables) can cause scratches if they get under pan bases. Make sure that the ceramic surface is clean before placing pans on it.
- ▶ Even a light object can cause damage in certain circumstances. Do not drop anything on the ceramic surface.
- ▶ Hot items placed down on the touch display can damage the electronics underneath. Never place hot pans in the area of the touch display.

Warning and Safety instructions

- ▶ Do not allow solid or liquid sugar, or pieces of plastic or aluminium foil to get onto the cooktop when it is hot, as they can damage the ceramic surface when it cools down. If this should occur, switch off the appliance and scrape off all the sugar, plastic or aluminium residues whilst still hot, using a shielded scraper blade suitable for use on glass. Wear oven gloves when doing this. Allow the ceramic surface to cool down and then clean it with a suitable ceramic cooktop cleaning agent.
- ▶ Acidic food such as vinegar, jams or lemon juice can cause discolouration to the ceramic surface. Remove acidic residues immediately.
- ▶ Pans which boil dry can cause damage to the ceramic glass. Do not leave the cooktop unattended whilst it is being used.
- ▶ Only use pots and pans with smooth bases. Rough bases will scratch the ceramic glass.
- ▶ Lift pans into position on the cooktop. Sliding them into place can cause scuffs and scratches.
- ▶ Because induction heating works extremely quickly, the base of the pan could heat up to the temperature at which oil or fat self-ignites within a very short time. Do not leave the cooktop unattended whilst it is being used.
- ▶ Do not use the Booster to heat fats and oils. Use the Manual 1–9 function to heat fats and oils for max. 1 minute.
- ▶ For people fitted with a heart pacemaker: please note that the area immediately surrounding the cooktop is electromagnetically charged when it is switched on. It is very unlikely to affect a pacemaker. However, if in any doubt, consult the manufacturer of the pacemaker or your doctor.

Warning and Safety instructions

- ▶ To prevent damage to items which are susceptible to electromagnetic fields, e.g. credit cards, digital storage devices, pocket calculators, etc., do not leave them in the immediate vicinity of the cooktop.
- ▶ Metal utensils stored in a drawer under the cooktop can become hot if the appliance is used intensively for a long time. Do not store any metal items or utensils in a drawer under the cooktop.
- ▶ If a drawer is fitted directly underneath the cooktop, do not store pointed or small items, paper, serviettes etc. in the drawer. They could get in through the ventilation slots or be sucked into the casing by the fan and damage the fan or impair cooling.
- ▶ If an induction adapter plate is used for cookware, the induction generator may be damaged or even destroyed. Do not use induction adapter plates.

Cleaning and care

- ▶ Do not use a steam cleaning appliance to clean this appliance. The steam could reach the electrical components and cause a short circuit.
- ▶ If the cooktop is built in over a pyrolytic oven, the cooktop should not be used whilst the pyrolytic process is being carried out, as this could trigger the overheating protection mechanism on the cooktop (see “Safety features - Overheating protection”).

Caring for the environment

Disposal of the packing material

The transport and protective packaging has been selected from materials which are environmentally friendly for disposal, and can normally be recycled.

Recycling the packaging reduces the use of raw materials in the manufacturing process and also reduces the amount of waste in landfill sites. Ensure that any plastic wrappings, bags etc. are disposed of safely and kept out of the reach of babies and young children. Danger of suffocation.

Disposing of your old appliance

Electrical and electronic appliances often contain valuable materials. They also contain specific materials, compounds and components, which were essential for their correct function and safety. These could be hazardous to human health and to the environment if disposed of with your domestic waste or if handled incorrectly. Please do not, therefore, dispose of your old appliance with your household waste.



Please dispose of it at your local community waste collection / recycling centre for electrical and electronic appliances. You are also responsible for deleting any personal data that may be stored on the appliance prior to disposal. Please ensure that your old appliance poses no risk to children while being stored prior to disposal.

Cooktop

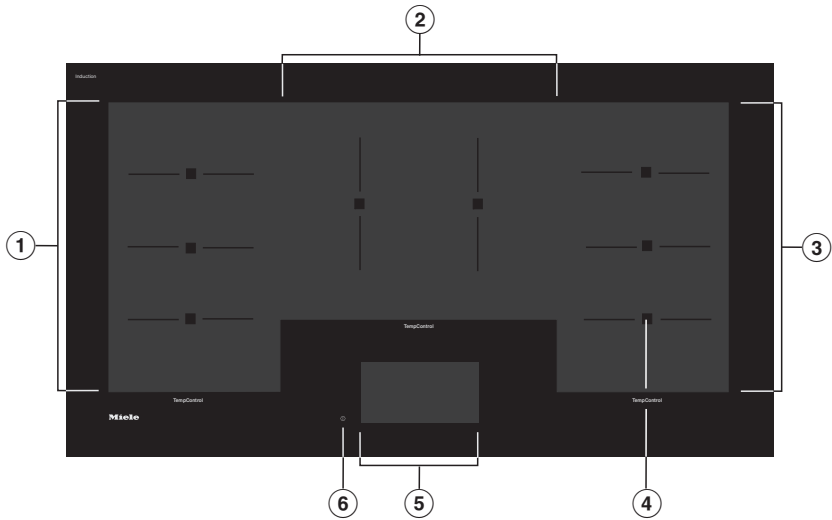

- ① PowerFlex Plus cooking area with TempControl
- ② PowerFlex Plus cooking area with TempControl
- ③ PowerFlex Plus cooking area with TempControl
- ④ Sensors for TempControl
- ⑤ Touch display
- ⑥ Cooktop On/Off

Overview

Cooking area data

| Cooking area | Size in mm ¹ | Max. rating in watts for 230 V ² | |
|--------------|-------------------------|---|--------------|
| ① | 382 x 226 | Normal Booster | 2800 3600 |
| ② | 286 x 365 | Normal Booster | 2800 3600 |
| ③ | 382 x 226 | Normal Booster | 2800 3600 |
| | | Total | 10800 |

¹ The given range corresponds to the maximum base surface of the pans that may be used.

² The power level given may vary depending on the size and material of the pans used.

Accessories supplied

The accessories supplied with your appliance, as well as a range of optional ones, are available to order from Miele (see “Optional accessories”).

Wi-Fi stick XKS 3170 W

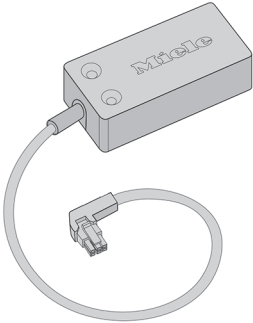

Controls

Touch display

 Risk of damage by sharp or pointed objects, and by hot pans.
The touch display can be scratched by pointed or sharp objects, e.g. pens.
Placing hot pans on the touch display can damage the electronic unit underneath.
Only touch the display with your fingers.
Do not place objects on the touch display.
Do not place hot pans on the touch display.

The touch display is divided into 3 areas.

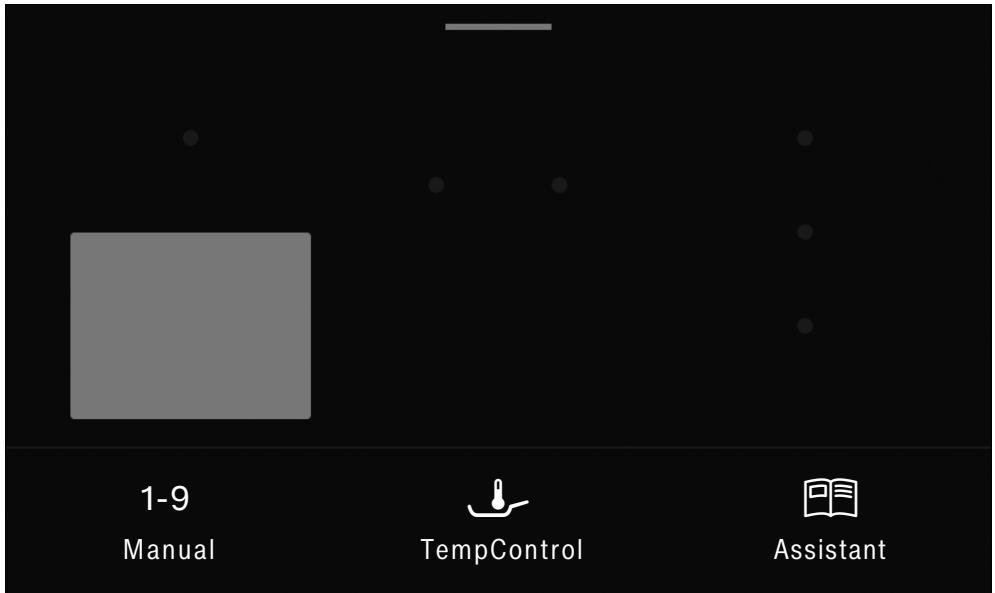

Top

At the top of the touch display there is an orange line that you can drag down to open the pull-down menu. You can adjust settings in the pull-down menu while cooking.

The menu path appears on the left of the header. The individual menu options are separated by a vertical line.

If you touch a menu name in the header, the display will switch to that menu.

Middle

The cooking areas are located in the middle section. Active cooking zones are highlighted in grey and indicate the programme running time if a cooking process has been started. Depending on the type of cooking, the set temperature or the power level will also be displayed. The selected cooking zone is highlighted in orange.



Footer

The symbols for the main menu are located in the footer. You can select the type of cooking here.





Controls

Symbols

Main menu



| Symbol | Meaning |
|--|--|
| 1-9 Manual | Manual cooking - selecting a power level |
|  TempControl | Sensor-controlled frying - selecting a temperature |
|  Assistant | Assistance function for the preparation of selected foods and recipes. |

Pull-down menu

| Symbol | Meaning |
|---|--|
|  | Wipe protection |
| i | This symbol indicates that there is additional information and advice about using the appliance. |
| ▶ | Stop & Go |
|  | Minute minder |
|  | System lock |
|  | Settings |

Other symbols

Other symbols appear depending on the function selected.

| Symbol | Meaning |
|---|---|
|  | Automatic switch-off |
|  | This will take you back to the previous menu or to the main menu. |

Cleaning the cooktop for the first time

- Remove any protective wrapping and stickers.
- Do not remove stickers carrying safety or installation information or the data plate.

This makes it easier to perform servicing and repair work.

- Before using for the first time, clean the cooktop with a damp cloth only and then wipe dry.

Switching on the cooktop for the first time

Setting the language

- Select the language you want.
- Confirm with OK.

Initial cooking

The metal components have a protective coating which may give off a slight smell when heated up for the first time. The induction coils may also give off a slight smell for the first few hours of operation. This smell will be less noticeable with each subsequent use before dissipating completely.

The smell and any vapours given off do not indicate a faulty connection or appliance and they are not hazardous to health.

Please note that the heating up time on induction cooktops is significantly shorter than on conventional cooktops.

Before using for the first time

Miele@home

Prerequisites:

- Home Wi-Fi network
- The Wi-Fi stick supplied with your appliance must be fitted.

Once the Wi-Fi stick has been fitted, the cooktop can be connected to the home Wi-Fi network.

If your Miele rangehood is also connected to the home Wi-Fi network, you can control the rangehood automatically via the Con@ctivity function. Further information can be found in the operating and installation instructions of your rangehood.

Make sure there is sufficient signal strength for your Wi-Fi network where the cooktop is installed.

There are a number of ways of connecting your cooktop to your Wi-Fi network.

The cooktop requires max. 2 W in networked standby.

Availability of the Wi-Fi connection

The Wi-Fi connection shares a frequency range with other appliances (including microwave ovens and remote control toys). This may result in sporadic or even complete connection failures. Therefore, a constant availability of featured functions cannot be guaranteed.

Miele@home availability

The ability to use the Miele App depends on the availability of the Miele@home service in your country.

The Miele@home service is not available in every country.

For information about availability, please visit www.miele.com.

Miele App

You can download the Miele App from the Apple App Store® or the Google Play Store™ free of charge (only functional in selected countries).



After installing the Miele App on a mobile device, you can do the following:

- Call up information on the operating status of your cooktop
- Call up information on the programme sequence of your cooktop
- Set up a Miele@home network with other Wi-Fi enabled Miele appliances

Before using for the first time

Setting up Miele@home

Connecting via the App

The Miele@mobile App can be used to connect to your network.

- Install the Miele@mobile App on your mobile device.

To log in you will need:

1. Your Wi-Fi network password.
2. The password of your cooktop

The password for your cooktop consists of the last nine digits of the serial number. The serial number can be found in Settings  under Software version (see "Additional functions - Displaying cooktop data").

- Switch the cooktop on.
- Mobile device: start the Miele@mobile App.
- Cooktop: open Settings .
- Cooktop: touch Miele@home | Activate | Sign on via App.
- Mobile device: follow the instructions in the App.

The message Connection successfully established appears in the touch display.

Connecting via WPS

You must have a WPS (Wi-Fi protected setup) compatible router.

- Switch the cooktop on.
- Cooktop: touch Miele@home | Activate | Sign on via WPS.
- Wi-fi router: activate the WPS function on your Wi-Fi router.

Cooktop: the message Connection successfully established appears in the touch display.

Useful tip: If your Wi-Fi router does not support WPS, please connect via the Miele@mobile App.

- Mobile device: follow the instructions in the App.



Before using for the first time

Cancelling the process

- Touch Deactivate.

Resetting settings

It is not necessary to reset when replacing the wireless stick or the router.

- Switch the cooktop on.
- Open the Settings  (see "Settings ").
- Touch Miele@home | Reset.

The message  Network settings reset appears in the touch display.

Reset the settings if you are disposing of your cooktop, selling it or putting a used cooktop into operation. This is the only way to ensure that all personal data has been removed and, in the case of the latter situation, the previous owner will no longer be able to access the cooktop.

Con@ctivity

Con@ctivity is the direct communication system between an electric Miele cooktop and a Miele rangehood.

Con@ctivity enables the rangehood to operate automatically depending on the operational state of your Miele cooktop.

Further information can be found in the operating and installation instructions of your rangehood.

The cooktop requires max. 2 W in networked standby.

Availability of the Wi-Fi connection

The Wi-Fi connection shares a frequency range with other appliances (including microwave ovens and remote control toys). This may result in sporadic or even complete connection failures. Therefore, a constant availability of featured functions cannot be guaranteed.

Setting up Con@ctivity

You can set up Con@ctivity via the home Wi-Fi network or via a direct Wi-Fi connection between the cooktop and the rangehood.

Con@ctivity via the home Wi-Fi network (Con@ctivity 3.0)

Prerequisites:

- Home Wi-Fi network
- The Wi-Fi stick supplied with your appliance must be fitted.
- Wi-Fi-enabled Miele rangehood.

- Connect the rangehood and the cooktop to your home Wi-Fi network (see “Before using for the first time – Miele@home”).

The Con@ctivity function will be activated automatically.

You will find the necessary information for integrating the rangehood in the relevant operating and installation instructions.



Before using for the first time

Con@ctivity via a direct Wi-Fi connection (Con@ctivity 3.0)

Prerequisites:

- The Wi-Fi stick supplied with your appliance must be fitted.
- Wi-Fi-enabled Miele rangehood.

You will find the necessary information for integrating the rangehood in the relevant operating and installation instructions.

- Switch the cooktop on.
- Open the Settings  (see "Settings ").
- Touch Miele@home | Activate | Con@ctivity.

The message **Connection successfully established** appears in the touch display.

When successfully connected, **2** and **3** will light up constantly on the rangehood.

- Quit connection mode on the rangehood by pressing the run-on control .

Con@ctivity has now been activated.



With a direct Wi-Fi connection, it is not possible to connect the cooktop and the rangehood to a home network. If this is desired later, the direct Wi-Fi connection between the cooktop and the rangehood must first be disconnected (see "Con@ctivity – Resetting settings" in these instructions and "Disconnecting the Wi-Fi" in the operating and installation instructions of the rangehood).

Cancelling the process

- Touch Deactivate.

Resetting settings

It is not necessary to reset when replacing the wireless stick or the router.

- Switch the cooktop on.
- Open the Settings  (see "Settings ").
- Touch Miele@home | Reset.

The message **Network settings reset** appears in the touch display.

Reset the settings if you are disposing of your cooktop, selling it or putting a used cooktop into operation. This is the only way to ensure that all personal data has been removed and, in the case of the latter situation, the previous owner will no longer be able to access the cooktop.

How it works

Induction coils are located under the ceramic surface. These coils create a magnetic field that reacts directly with the base of the pan and heats it up. The ceramic surface itself is heated up indirectly by the heat given off by the pan.

The position, size and shape of the pots and pans are recognised automatically by the induction cooktop.

An induction cooktop only works when a pan with a magnetic base is placed on it (see "Cookware").

⚠ Risk of burning due to hot items!

When the cooktop is switched on, either deliberately or by mistake, or when there is residual heat present, there is a risk of metal items placed on the cooktop heating up.

Do not use the cooktop as a resting place for anything else.

After use, switch the cooktop off with the ① sensor control.

Cooking areas

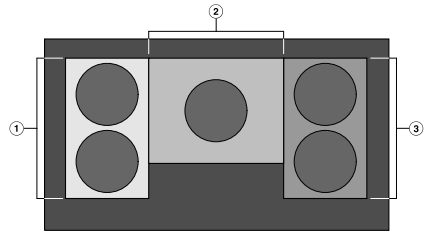

- ① PowerFlex Plus cooking area with TempControl
- ② PowerFlex Plus cooking area with TempControl
- ③ PowerFlex Plus cooking area with TempControl

The cooktop has 3 cooking areas. The entire cooking surface can be divided into individual cooking zones across all cooking areas.

You can use a maximum of 5 pans at the same time: 2 pans each on the left and right cooking areas, and 1 pan on the middle area.

If 2 pans are being used on either the left or right cooking area, an indicator appears for each pan in the touch display.

If necessary, multiple pans can cover multiple cooking areas at the same time.

For more information about cooking areas and combination options, see "Operation - Positioning cookware".

Noises

The following noises can occur in the pan, depending on what it is made of and how it has been constructed.

On the higher power levels, the appliance might buzz. This will decrease or cease altogether when the power level is reduced.

If the pan base is made of layers of different materials (e.g. in a sandwiched base), it might emit a crackling sound.

You might hear a clicking sound from the electronic switches, especially on lower power levels.

You might hear a whirring sound when the cooling fan switches on. It switches on to protect the electronics when the cooktop is being used intensively. The fan may continue to run after the appliance has been switched off.

How it works

Power Management

The cooktop has a maximum total permitted power consumption which cannot be exceeded for safety reasons.

If you are cooking on either the left or right cooking area with 2 pans, the power output is regulated so that the total power output is not exceeded.

Example:

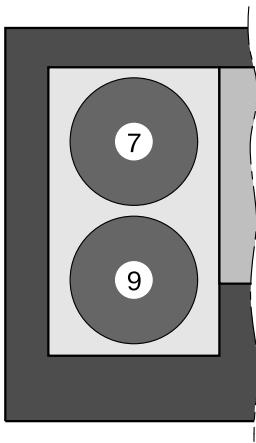

If power level 9 is selected for the front left cookware, the maximum available power output available for the rear left cookware will be power level 7.

The cooktop is set ex-works to a total power output of 10,800 W. The total power output can be reduced to 7200 W (see "Settings" – "Settings overview").

Reducing the total power output to 7200 W has the following effects:

- A high power level cannot be selected for very large pans.
- If you are cooking on either the left or right cooking area with 2 pans, only the Manual 1-9 function can be used.

Suitable pans

- stainless steel pans with a base that can be magnetised
- enamelled steel pans
- cast iron pans

Please be aware that the properties of the pan base can affect the evenness with which the food heats up (e.g. when making pancakes). The base of the pan must be able to distribute the heat evenly. A sandwich base made of stainless steel is particularly suitable.

The pan base material and the positions of the pans on the cooktop affect the power of the induction coils. This can affect the cooking behaviour.

Unsuitable pans

- stainless steel pans with a base which cannot be magnetised
- aluminium or copper pans
- glass, ceramic or earthenware pots and pans

Testing cookware

To test whether a pot or pan is suitable for use on an induction cooktop, hold a magnet to the base of the pan in several different places. If the magnet sticks, the pan is generally suitable.

No pan/Unsuitable pan display

- - - flashes in the touch display if
- a cooking zone has been switched on without cookware in place, or if the cookware is unsuitable (non-magnetic base).
- the diameter of the base of the pan is too small.
- the cookware is taken off the cooking zone while it is switched on.
- the pan is not positioned correctly.

If a suitable pan is placed on the cooking area or repositioned within 1 minute, - - - will go out and you can continue as normal.

If no cookware or an unsuitable cookware is placed on the cooking zone, the cooking zone will switch off automatically after 1 minute.

Cookware

Useful tips

- Use only pots and pans with smooth bases. Rough bases can scratch the ceramic glass.
- Always lift the cookware to move it. This will help prevent scratching. If any scratches do appear as a result of cookware being pushed around, this will not affect the function of the cooktop. These scratches are normal signs of use and are not grounds for making a complaint.
- Please note that the maximum diameter quoted by manufacturers often refers to the diameter of the top rim of the pot or pan. The diameter of the base (generally smaller) is more important.

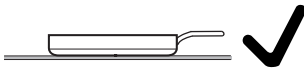

- Where possible, use pans with vertically straight sides. If a pan has angular sides, induction also acts on the sides of the pan. The sides of the pan may discolour or the coating may peel off.

Tips on saving energy

- Use a lid whenever possible to minimise heat loss.
- Select a smaller pan when cooking small quantities. A smaller pan uses less energy than a larger pan with very little in it.
- Cook with as little water as possible.
- Once food has come to the boil or the oil in the pan is hot enough for frying, reduce the heat to a lower setting.
- Use a pressure cooker to reduce cooking times.

Power level range

The cooktop is programmed with 9 power levels at the factory. If you wish to fine-tune a setting, you can extend the power level range to 17 power levels (see "Settings").

| | Power level range | |
|--|----------------------------------|-------------------------------------|
| | Default setting (9 power levels) | Extended settings (17 power levels) |
| Melting butter Melting chocolate Dissolving gelatine | 1–2 | 1–2. |
| Warming up small quantities of liquid Keeping warm food which sticks easily Cooking rice or porridge Defrosting vegetables frozen in a block | 2–4 | 2–3. |
| Warming up liquid and semi-solid food Steaming fruit Simmering potatoes (pans with lids) | 4–6 | 3.–5. |
| Making omelettes or lightly fried eggs Gently frying rissoles Steaming fish and vegetables Cooking dumplings and dried pulses Defrosting and warming up frozen food Thickening sauces, e.g. Hollandaise | 5–7 | 4.–7. |
| Gently frying meat, fish, sausages and eggs (without overheating the fat) | 6–8 | 6–7. |
| Cooking potato fritters, pancakes etc. | 7–8 | 7–8. |
| Boiling large quantities of water Bringing to the boil Searing large amounts of meat | 9 | 8.–9 |

These settings should only be taken as a guide. The power of the induction coils will vary depending on the size and material of the pan. For this reason, it is possible that the settings will need to be adjusted slightly to suit your pans. As you use the cooktop, you will get to know which settings suit your pans best. When using new pans that you are not familiar with, set the power level below the one specified.

Operating principles

This ceramic cooktop is equipped with an electronic On/Off ① sensor which reacts to fingertip contact. For safety reasons, when switching the appliance on, the On/Off ① sensor needs to be touched for a little longer.

Only the printed On/Off ① symbol is visible when the cooktop is switched off. The touch display lights up when the cooktop is switched on.

You operate the cooktop via the touch display by touching the desired menu option.

Each time you touch the touch display, an acoustic signal sounds.

Each time you touch a possible option the relevant characters (word and/or symbol) light up **orange**.

Fields for confirming an operating step are highlighted in **green** (e.g. OK).

⚠ Malfunction due to a dirty and/or covered touch display.

If the touch display is dirty or covered, this could cause it to fail to react, to activate a function inadvertently, or even for a fault message to appear (see "Safety features - Safety switch-off"). Placing hot pans on the touch display can damage the electronic unit underneath.

Please keep the touch display clean.

Do not place objects on the touch display.

Do not place hot pans on the touch display.

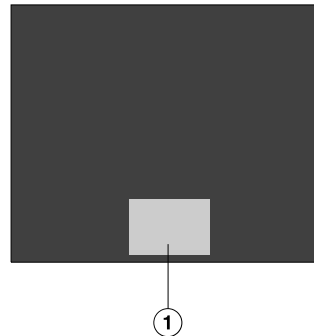

① Touch display area

Operation

Selecting a menu option

- Touch the desired field or value in the touch display.

Displaying the pull-down menu

- Touch the orange line at the top edge of the touch display.
- Select the function you want.
- To close the pull-down menu, drag it back up to the top or touch an area of the display located outside of the menu window.

Scrolling through menus

You can scroll left or right.

- Swipe across the screen. To do this, place your finger on the touch display and swipe it in the direction you want.

The bar at the bottom shows you where you are in the current menu.

Exiting a menu

- Touch the ↩ symbol or touch the menu path before the last I symbol.

Entries made before this which have not been confirmed with OK will not be saved.

Changing a setting in a list

The current setting is highlighted in orange.

- Touch the desired setting.

The setting is now saved. This will take you back to the previous menu.

Pan recognition

Permanent pan recognition is activated as standard (see "Settings"). When the cooktop is switched on and you place a pan on it, the respective indicator automatically appears in the touch display.

If pan recognition is deactivated, you need to touch the relevant area for the position of the pan on the touch display to switch on the area.

Positioning cookware

- Position cookware as illustrated on the cooking area diagrams. As a result:
 - an even heat distribution is ensured
 - a TempControl sensor detects suitable cookware

 Risk of fire from overheating. Overheating can occur if a sensor is unable to function correctly. Position the cookware centrally over a sensor.

Cookware minimum size

Depending on the function and cooking area, your cookware must have the following minimum base diameter:

| Cooking area | Manual | TempControl |
|--------------|--------|-------------|
| Left/Right | 11 cm | 13 cm |
| Middle | 11 cm | 16 cm |

Right and left cooking areas

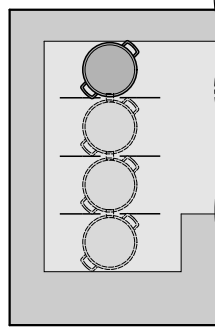

Pans with a base diameter smaller than 13 cm.

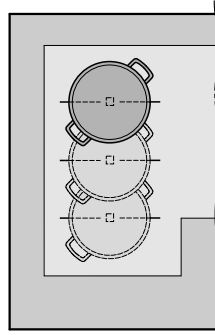

Pans with a base diameter larger than 13 cm.

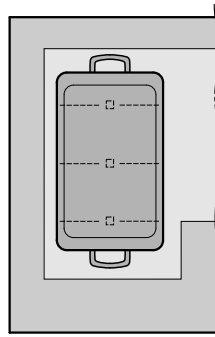

Larger pans

Operation

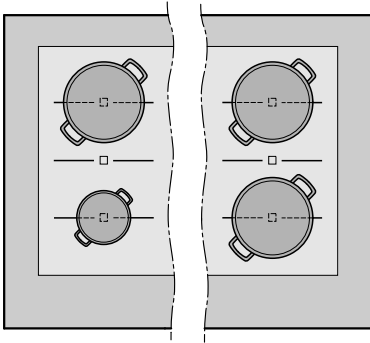

2 pans

Middle cooking area

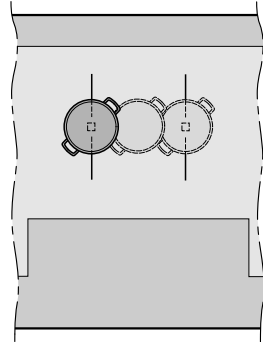

Pans with a base diameter smaller than 16 cm.

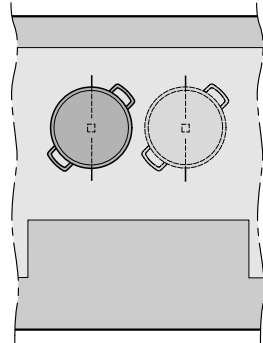

Pans with a base diameter larger than 16 cm.

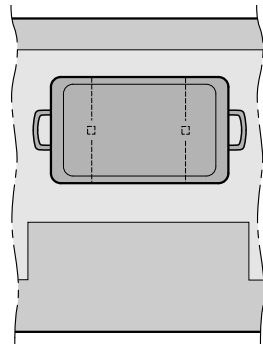

Pans with a base diameter larger than 25 cm.

 Risk of fire due to overheated food.
Unattended food can overheat and ignite.
Do not leave the cooktop unattended whilst it is being used.

Please note that the heating-up time on induction cooktops is much shorter than on conventional cooktops.

Switching on the cooktop

- Touch the ① sensor.

The touch display is switched on.

If no further entry is made, the appliance will switch itself off after 1 minute for safety reasons.

Setting the power level

- Place the cookware in the required position on the cooktop.
- Select Manual 1–9.
- Touch the required power level or swipe the bar.

The selected power level, the settings range and the duration will be displayed.

The running time indicates how long the cooking zone has been in use for.

If you swipe over the duration display, the display will revert to 0.

Changing the power level

If you are cooking with multiple pans at the same time and the required display is not orange, you need to first select the display.

- Touch the display for the pan you want.
- Set the power level.

Switching off a cooking zone/ the cooktop

Switching off a cooking zone

- Touch and hold the cooking zone in the touch display until the cooking zone switches off.

or

- Touch the cooking zone in the touch display.
- Set the power level to 0.

or

- Touch the cooking zone in the touch display.
- Touch the ↶ symbol.

Switching the cooktop off

- To switch off the cooktop and all the cooking zones, touch the ① sensor.

Operation

Residual heat indicator

If the cooking zone is still hot, the cooktop's residual heat indicator  will light up after it has been switched off.

The residual heat indicator remains on until the cooking zone is cool enough to touch.



Risk of burning due to hot ceramic surface.

The ceramic surface will be hot after use.

Do not touch the ceramic surface while the residual heat indicators are on.

TempControl

TempControl monitors and controls the temperature during frying:

- The fat cannot overheat.
- The power levels do not need to be adjusted manually.
- It is not necessary to frequently turn the food being fried.

Position pans centrally over the sensor.

TempControl is not suitable for deep fat frying and boiling.
Use this function for normal frying only.

Notes on use

- The temperature can be set between 140–230 °C.
- The outside of the pan must be dry when it is placed on the cooktop.
- Do not use oil if it is already hot, discoloured or cloudy, or oil that contains particles of food.
- Only add food once the tone sounds. If any irregularity is detected, the appliance might not continue to heat up.
- Do not add any more oil once the pre-heating phase has started.
- Do not place the pan in a different position after the pre-heating phase has started.
- Make sure that the ceramic surface is kept clean, particularly in the area of the sensor in the middle of the cooking area.
- Use pans which distribute heat evenly, e.g. pans with a sandwich base.

Operation

Activating TempControl

- Place the cookware in the required position on the cooktop.
- Place the required amount of oil or fat in the pan.
- Select TempControl .
- Set the temperature.

A tone sounds when the set temperature is reached. The duration will start automatically.

- Place the food to be fried in the pan.
- Switch the cooking zone off after use.

Changing the temperature

If you are cooking with multiple pans at the same time and the required display is not orange, you need to first select the display.

- Touch the display for the pan you want.
- Set the temperature.

TempControl cooking chart

Only food is listed for which there is no assistance programme. See "Operation - Assistant" for a complete list of the assistance programmes.

The temperatures given in the tables are guidelines only. We recommend selecting the lower temperature first. You can cook for longer if necessary. The duration only begins when the set temperature is reached.

| Food | 🌡️ [°C] |
|--|---------|
| Frozen meat, e.g. Cordon bleu | 150–170 |
| Frozen spring rolls | |
| Frozen fish fingers | |
| Whole fish | |
| Kebabs | |
| Vegetables in butter (mushrooms, garlic) | |
| Schupfnudeln (potato noodles) in butter | |
| Potato pancakes | 180–200 |
| Meat loaf | |
| Tortilla | |
| Langos (Hungarian flatbread) | |
| Popcorn | |
| Frozen stir-fried dishes | |
| Dry-roasting seeds | |
| Caramel | 200–220 |
| Sliced meat | |
| Cooking with a wok | |
| Searing meat for stews (e.g. goulash) | 200–220 |
| Searing large quantities of meat | |

🌡️ Temperature

Operation

Setting the power level - extended power level range

- Touch the numerical keybank between the power levels.

The selected power level, the settings range and the duration will be displayed.

Example:

If you touch the numerical keypad between power levels 7 and 8, the power level 7.5 will be selected.

The running time indicates how long the cooking zone has been in use for.

PowerFlex Plus cooking area

In a PowerFlex Plus cooking area all induction coils (see "Induction - How it works") are permanently switched on together. If pan recognition is activated (see "Settings "), the cooking zones are automatically set based on the size of the pan being used. You can also select the cooking zones manually and alter the shape and/or size.

Position the pan centrally on the PowerFlex Plus cooking area.

Setting/Changing cooking zones manually

- Touch the square marking on the touch display of the cooktop.

The selected area is highlighted in orange.

- Slide your finger across the touch display to either enlarge or reduce the size of the selected area.

You cannot change the shape or size of an activated cooking zone.

Booster

When activated, the power is boosted so that large quantities can be heated up quickly, e.g. when boiling water for cooking pasta. The boost in power is active for a maximum of 10 minutes.

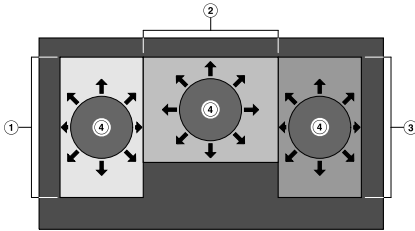

- ① PowerFlex Plus cooking area with TempControl
- ② PowerFlex Plus cooking area with TempControl
- ③ PowerFlex Plus cooking area with TempControl
- ④ Cookware with Booster

The Booster function can be used with a maximum of 3 pans at the same time:

- 1x on the left half of the cooktop.
- 1x in the middle.
- 1x on the right half of the cooktop.

When you activate the Booster, the cooktop will automatically revert to power level 9 at the end of the Booster time.

While the Booster is in operation, some of the power is taken away from the other induction coils. If another pan is in use on the same side of the cooktop, it will be affected as follows:

- The power level is reduced.
- High power levels cannot be set.

The Booster and TempControl functions cannot be used together on the same side of the cooktop.

The settings in Power Management (see "Induction - Power Management") influence the Booster function.

Operation

Activating the Booster

- Place the cookware in the required position on the cooktop.
- Select Manual 1–9.
- Touch the B symbol.

B, the settings range and the duration will appear in the display.

The running time indicates how long the cooking zone has been in use for.

Deactivating the Booster

- Touch the ↶ symbol.

or

- Set a different power level.

Assistant

Your cooktop offers you more than 20 assistance programmes for preparing dishes and foods.

- Place the pan on the desired cooking area.
- Select Assistant .
- Select the dish/food you want.

Information about the food or dish you have selected will appear in the touch display.

- Select Start.

A tone sounds when the set temperature is reached. The duration will start automatically. No further tones will sound.

The recipe suggests cooking times.

Useful tip: You can set your cooking time for the cooking zone as a short time or as an automatic switch-off time (see chapter "Timer").

- Follow the "Information" instructions.
- Switch the cooking zone off after use.

Accessing the Information display

You can access information regarding a current cooking process.

- Touch the  symbol in the cooking zone display.
- Touch Start to close the display.

Operation



Assistance programme overview

The cooking durations given in the tables are guidelines only. We recommend selecting the shorter duration initially. You can cook for longer if necessary. The duration only begins when the set temperature is reached.

| Food | 🌡️ [°C] | 🕒 [min] |
|-----------------------------|---------|--------------------|
| Side dishes | | |
| Fried potatoes | 180–200 | 15–25 ¹ |
| Croutons | 200 | 4–6 |
| Fish | | |
| Plain fish fillet | 180–200 | 5–15 |
| Breaded fish fillet | 180–200 | 5–15 |
| Prawns | 180–200 | 2–4 |
| Snap cuisine | | |
| French toast | 180–200 | 6–10 |
| Curry | 200–210 | 10–20 ² |
| Croque monsieur | 180–200 | 6–10 |
| Stir-fried dishes | 200 | 3–10 |
| Eggs | | |
| Omelette | 160–180 | 3–6 |
| Fried egg | 160–180 | 5–10 |
| Scrambled egg | 160 | 2–6 |
| Meat | | |
| Bolognese sauce | 180–220 | 30–90 ³ |
| Meat patties | 160–180 | 10–20 |
| Pan fried chicken breast | 180–220 | 10–20 |
| Escalopes | 180–200 | 5–10 |
| Steak rare, 3 cm thick | 200 | 5–7 |
| Steak medium, 3 cm thick | 200 | 6–10 |
| Steak well done, 3 cm thick | 160 | 15–25 |

Operation

| | | |
|------------|---------|------|
| Sausages | 180 | 5–15 |
| Bacon | 160–180 | 8–11 |
| Lamb chops | 180–220 | 5–10 |
| Pork chops | 180–200 | 6–10 |
| Sweets | | |
| Pancakes | 160–180 | 4–8 |
| Crêpes | 200 | 2–3 |

 Temperature,  Duration

¹ The duration given refers to boiled potatoes.

If the potatoes have not been boiled and are diced or sliced, the duration is 15–35 minutes.

² After frying ingredients, add stock and bring to the boil.

The duration refers to the time after bringing the stock to the boil.

³ After frying ingredients, add stock and bring to the boil.

The duration refers to the time after bringing the remaining ingredients to the boil.

Timer

The cooktop has to be switched on if you wish to use the timer.

The timer can be used for the following 2 functions:

- For setting the minute minder
- For automatically switching off the heating of a pot or pan

You can use the functions simultaneously.

A duration of between 1 minute (0:00:01) and 9 hours 59 minutes and 59 seconds (9:59:59) can be set.

Minute minder



Setting the minute minder

- Open the pull-down menu.
- Select .
- 0:00:00 (hours:minutes:seconds) will appear in the touch display.
- Touch 0 (hours) or 00 (minutes or seconds).
- Set the time you want using the - or + sensor.
- Touch OK to confirm.

Changing the time set for the minute minder

- Select .
- Touch the value you wish to change.
- Set the time you want using the - or + sensor.
- Touch OK to confirm.

Cancelling the minute minder

- Select .
- Select .
- Touch OK to confirm.

Auto switch-off

You can set a time after which the cooking zone will switch off automatically. This function can be used on all zones at the same time.

If the time programmed is longer than the maximum operational time allowed, the safety switch-off will switch off the cooking zone after the maximum permitted safety time has elapsed (see "Safety features - Safety switch-off").



Setting the switch-off time

- Select a power level or temperature for the cooking zone you wish to use.
- Select .
- 00:00:00 (hours:minutes:seconds) will appear in the touch display.
- Touch 0 (hours) or 00 (minutes or seconds).
- Set the time you want using the - or + sensor.
- Touch OK to confirm.
- If you want to set another cooking zone to switch off automatically, follow the same steps as described above.

Changing the switch-off time

- Select .
- Touch the value you wish to change.
- Set the time you want using the - or + sensor.
- Touch OK to confirm.

Deleting the switch-off time

- Select .
- Select .
- Touch OK to confirm.

The duration will no longer be visible once you have deleted a time.

Additional functions

Stop & Go

This function can only be used when the Manual 1–9 function is being used for all pans. When Stop & Go is activated, all power levels are reduced to 1.

The power levels and the timer settings cannot be altered; the cooktop can only be switched off. The minute minder time, switch-off times and Booster durations are all halted.

When the function is deactivated, the appliance switches back to the power level that was set last and the times will continue to run.

Activating/Deactivating

If the function is not deactivated within 30 minutes, the cooktop will switch off.

- Open the pull-down menu.
- Touch the **II/▶** symbol for approx. 1 second.

Recall

If the cooktop is switched off inadvertently during operation, this function can be used to reset all settings. For this to work, the cooktop must be switched on again within 10 seconds of being switched off.

- Switch the cooktop on again.
- Select **Yes**.

All the power levels and the times will continue to operate using the settings selected previously.

Wipe protection

The cooktop touch display can be locked for 20 seconds in order, for example, to remove soiling. The ① sensor control is not locked.

Activating

- Open the pull-down menu.
- Touch the  symbol.

The time will count down under the  symbol.



Deactivating

- Open the pull-down menu.
- Touch the  symbol.

Demonstration mode



This function enables the cooktop to be demonstrated in showrooms without heating up.

Activating

- Open the Settings  (see "Settings ").
- Touch Demo mode | On.

DEMO appears in the middle of the touch display.



Deactivating

- Open the Settings  (see "Settings ").
- Touch Demo mode | Off.

DEMO goes out in the touch display.

Displaying cooktop data

The model designation, serial number and software version can be displayed.

- Open the Settings  (see "Settings ").
- Touch Software version.

The cooktop data appears in the touch display.

Safety features

System lock

Your cooktop is equipped with a system lock to prevent it being switched on by mistake. The system lock can only be activated when the cooking zones are all switched off.

Activating/Deactivating the system lock

- Switch the cooktop on.
- Open the pull-down menu.
- Touch the  symbol for 3 seconds.

Safety switch-off

Touch display is covered

Your cooktop will switch off automatically if the touch display remains covered for longer than 10 seconds, for example, by finger contact, food boiling over or by an object such as an oven glove or tea towel. The touch display shows the fault message F6716 and a tone sounds. Remove the objects and/or soiling, press OK and the cooktop will be ready to use again.

Excessive operating time

The safety switch-off mechanism is triggered automatically if an area is heated for an unusually long period of time. This time depends on the power level selected. If it has been exceeded, the heat switches off and the residual heat indicator will appear. A power level can be selected in the usual way.

| Power level* | Maximum operating time [h:min] |
|--------------|--------------------------------|
| 1/1. | 9 |
| 2/2. | 8 |
| 3/3. | 7 |
| 4/4. | 6 |
| 5/5. | 5 |
| 6/6. | 4 |
| 7/7. | 3 |
| 8/8. | 2 |
| 9 | 1 |

* The power levels with a dot after the number are only available if the power level range has been extended (see "Power level range").

Overheating protection

If the base of the pan overheats, the power level is automatically reduced. The display does not alter. The power level resumes to a normal level once the pan has cooled down.

Settings

You can adjust the cooktop to your individual needs in the Settings  menu.

Accessing Settings

Settings cannot be altered while a cooking programme is in progress.

- Switch the cooktop on.
- Open the pull-down menu.
- Select Settings .

Changing Settings

- Select the required menu option.

The current setting is highlighted in orange.

- Select the desired option.
- Touch OK to confirm.

If you want to exit the menu option without making any changes, touch Settings.

Settings overview

| Menu option | Available settings |
|--|---|
| Display brightness | 1 – 5 |
| Language  | .../deutsch/english/... |
| Permanent pan recognition | On* |
| | Off |
| Recall function | On* |
| | Off |
| Buzzer tones | On* |
| | Off |
| Power Management | 10,800 W* |
| | 7200 W |
| Power settings | without intermediate levels (1, 2, 3 etc.)* |
| | with intermediate levels (1, 1.5, 2, 2.5, 3 etc.) |
| Duration | On* |
| | Off |
| Assistant | On* |
| | Off |
| Factory default settings | Yes |
| | No |
| Software version | |
| Miele@home | See "Before using for the first time - Setting up Miele@home" and "Setting up Con@ctivity". |
| Demo mode | On |
| | Off* |

* Factory default setting

Cleaning and care



Risk of burning due to hot surfaces.

The ceramic surface will be hot after use.

Switch the cooktop off.

Allow the ceramic surface to cool down before cleaning the cooktop.



Risk of damage due to moisture ingress.

The steam from a steam cleaning appliance could reach electrical components and cause a short circuit.

Do not use a steam cleaner to clean the cooktop.

All surfaces could be discoloured or damaged if unsuitable cleaning agents are used. All surfaces are susceptible to scratching.

Remove all cleaning agent residues immediately.

Never use abrasive sponges or cleaning agents.

Allow the cooktop to cool down before cleaning.

- Clean the cooktop after every use.
- Dry the cooktop thoroughly after every cleaning to avoid limescale residue.

Unsuitable cleaning agents

To avoid damaging the surfaces of the appliance, do not use:

- washing-up liquid,
- cleaning agents containing soda, alkalines, ammonia, acids or chlorides,
- cleaning agents containing descaling agents,
- stain and rust removers,
- abrasive cleaning agents, e.g. powder cleaners and cream cleaners,
- solvent-based cleaning agents,
- dishwasher cleaner,
- grill and oven cleaners,
- glass cleaning agents,
- hard, abrasive brushes or sponges (e.g. pot scourers), or sponges which have been previously used and still contain abrasive cleaning agents,
- dirt erasers.

Cleaning the ceramic surface

 Risk of damage by pointed objects.

The seal between the cooktop and the worktop could be damaged.

The seal between the ceramic surface and the frame could incur damage.

Do not use pointed objects for cleaning.

Using washing-up liquid will not remove all soiling and residues. An invisible film can develop that can lead to discolouration of the ceramic glass. This discolouration cannot be removed.

Clean the ceramic surface regularly with a proprietary ceramic glass cleaning agent.

- Remove any coarse soiling with a damp cloth and more stubborn soiling with a glass scraper.
- Then clean the ceramic glass surface with the Miele ceramic and stainless steel cooktop cleaner (see “Optional accessories - Cleaning and care products”) or with a proprietary ceramic glass cleaner applied with a paper towel or a clean cloth. Do not apply the cleaner while the cooktop is still hot, as this can result in marking. Please follow the cleaning agent manufacturer's instructions.
- Finally wipe the cooktop with a damp cloth and dry it with a soft, dry cloth.

Residues can burn onto the cooktop the next time it is used and cause damage to the glass ceramic surface. Ensure that all cleaner residues are removed.

- **Spots** caused by limescale, water and aluminium residues (spots with a metallic appearance) can be removed using the Miele ceramic and stainless steel cooktop cleaner.

 Risk of burning due to hot surfaces.

The ceramic surface is hot during use.

Wear oven gloves when removing residues of sugar, plastic or aluminium foil from a hot cooktop with a glass scraper.

- Should any **sugar, plastic or aluminium foil** spill or fall onto the hot ceramic surface, first switch off the appliance.
- Then carefully scrape off these residues **immediately** whilst they are still hot, using a shielded scraper blade suitable for use on glass.
- Afterwards, clean the ceramic surface in its cooled state, as described above.

Problem solving guide



With the help of the following guide, minor faults in the performance of the appliance, some of which may result from incorrect operation, can be remedied without contacting Miele. This will save you time and money because you won't need a service call.

Please note that a call-out charge will be applied to unnecessary service visits where the problem could have been rectified as described in these operating instructions.

Messages in the display

| Problem | Possible cause and remedy |
|---|--|
| F6713 or F6771 appears in the touch display and the cooktop switches itself off automatically. | An empty pan was heated up. <ul style="list-style-type: none">■ Touch OK.■ Wait until the residual heat indicator  goes out (see "Operation - Residual heat indicator").■ Cook only with filled pans. |
| F6734 appears in the touch display and the cooktop switches itself off automatically. | The cookware is incorrectly positioned. <ul style="list-style-type: none">■ Position the pan correctly (see "Operation - Positioning cookware").■ Touch OK. |
| F6716 appears in the touch display and the cooktop switches itself off automatically. | The touch display is covered, e.g. by finger contact, food boiling over, or an object. <ul style="list-style-type: none">■ Clean off any dirt and/or remove the object (see "Safety features - Safety switch-off").■ Touch OK. |
| F6704 appears in the touch display and the cooktop switches itself off automatically. | The ventilation gaps of the cooling system are blocked. <ul style="list-style-type: none">■ Remove any impediments from in front of the ventilation gaps of the cooling system.■ Touch OK. |
| The display shows a message not listed in this table. | There is an electronic unit fault. <ul style="list-style-type: none">■ Interrupt the power supply to the cooktop for approx. 1 minute.■ If the problem persists after power is restored, please contact Miele. |

Unexpected behaviour

| Problem | Possible cause and remedy |
|---|---|
| <p>- - - flashes in the display.</p> | <p>There is no pan on the cooking area, or the pan is unsuitable.</p> <ul style="list-style-type: none"> ■ Use suitable pans (see "Induction - Cookware"). |
| | <p>The pan is not positioned correctly.</p> <ul style="list-style-type: none"> ■ Reposition the pan. |
| | <p>Metal objects such as cutlery are on the cooking area.</p> <ul style="list-style-type: none"> ■ Remove any obstruction. |
| <p>The touch display is not reacting.</p> | <p>Your fingertips are covered.</p> <ul style="list-style-type: none"> ■ Touch the display with bare fingers only. |
| | <p>Wipe protection  has been activated.</p> <ul style="list-style-type: none"> ■ Deactivate wipe protection (see "Additional functions - Wipe protection "). |
| | <p>You have touched the touch display while holding a pan.</p> <ul style="list-style-type: none"> ■ Only touch the touch display when both of your hands are free. |
| | <p>The touch display is dirty.</p> <ul style="list-style-type: none"> ■ Remove any soiling. |
| <p>The symbols react when an adjacent area is touched.</p> | <p>Water or liquid has accumulated on the touch display.</p> <ul style="list-style-type: none"> ■ Dry the touch display. |
| <p>The power level is reduced automatically or cannot be increased.</p> | <p>Two pans are being used on one cooking area at the same time (see "Induction - Power Management").</p> |
| <p>An area switches itself off automatically.</p> | <p>It has been operated for too long.</p> <ul style="list-style-type: none"> ■ Set a power level again (see "Safety features - Safety switch-off"). |
| <p>An area is not working in the usual way on the power level selected.</p> | <p>The overheating protection mechanism has been activated.</p> <ul style="list-style-type: none"> ■ If the base of the pan overheats, the power level is automatically reduced. The display does not alter. The power level resumes to a normal level once the pan has cooled down. |

Problem solving guide

| Problem | Possible cause and remedy |
|---|---|
| An area or the whole cooktop switches off automatically. | The overheating protection mechanism has been activated. ■ See “Safety features - Overheating protection”. |

Unsatisfactory results

| Problem | Possible cause and remedy |
|---|---|
| The heating-up time is unusually long. | The pan is not positioned correctly. ■ Reposition the pan (see "Operation - Positioning cookware"). |
| | The base of the pan or the ceramic surface is dirty. ■ Remove any soiling. |
| | You added water, oil or food during the heating-up phase. ■ Do not add anything during the heating-up phase. |
| In comparable cooking and frying processes there are slight differences in cooking durations and browning. | This is not a fault. The pan base material and the positions of the pans on the cooktop affect the power of the induction coils. This in turn affects the cooking behaviour. |

Problem solving guide

General problems or technical faults

| Problem | Possible cause and remedy |
|--|---|
| The cooktop cannot be switched on. | <p>There is no power to the cooktop.</p> <ul style="list-style-type: none">■ Check if the circuit breaker has tripped. Contact an electrician or Miele (for the minimum fuse rating, see data plate). <p>There may be a technical fault.</p> <ul style="list-style-type: none">■ Disconnect the cooktop from the mains electricity supply for approx. 1 minute. To do this:<ul style="list-style-type: none">– switch off at the wall socket and withdraw the plug, or– switch off the mains circuit breaker or residual current device.■ If, after switching the circuit breaker or residual current device back on, the appliance will still not switch on, contact a qualified electrician or Miele. |
| The cooking area is not heating up. | <p>The cooking area is still too hot from a previous cooking process. It will heat up once the cooking area has cooled down sufficiently.</p> |
| A smell and vapours are given off when the new appliance is being used. | <p>The metal components have a protective coating. When the appliance is used for the first time, this causes a smell and possibly also vapour. The material from which the induction coils are made also gives off a smell in the first few hours of operation. This smell will be less noticeable with each subsequent use before dissipating completely. The smell and any vapours given off do not indicate a faulty connection or appliance and they are not hazardous to health.</p> |
| A noise can be heard after the appliance is switched off. | <p>The fan will continue running until the cooktop has cooled down. It will then switch itself off automatically.</p> |

Miele offers a range of useful accessories, as well as cleaning and conditioning products for your appliance.

These products can be ordered from the Miele online shop.

They can also be ordered directly from Miele (see end of this booklet for contact details).

Cookware

Miele offers a large selection of cookware for purchase. These have all been optimised in terms of functionality and dimensions for Miele appliances. Detailed information can be found on the Miele website.

Cleaning and care products

Original Miele ceramic and stainless steel cooktop cleaner 250 ml



Removes heavy soiling, limescale deposits and aluminium residues.

Original Miele all purpose microfibre cloth

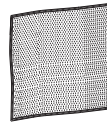

Removes finger marks and light soiling.

Service

Contact in case of fault

In the event of any faults which you cannot remedy yourself, please contact Miele.

You can book a Miele customer service call-out online at www.miele.com.au/service or www.miele.co.nz/service.

Contact information for Miele can be found at the end of this booklet.

Please quote the model and serial number of your appliance when contacting Miele. This information can be found on the data plate.

Warranty

The manufacturer's warranty for this appliance is 2 years.

For further information, please refer to your warranty booklet.

Safety instructions for installation

 Risk of damage from incorrect installation.
Incorrect installation can cause damage to the cooktop.
The cooktop must only be installed by a qualified person.

 Risk of electric shock.
Incorrect connection to the power supply may result in an electric shock.
The cooktop must be connected to the power supply by a qualified electrician.

 Damage from falling objects.
Take care not to damage the cooktop when fitting wall units or a rangehood above it.
Fit the wall units and the rangehood before the cooktop.

- ▶ The veneer or laminate coatings of worktops (or adjacent kitchen units) must be treated with 100 °C heat-resistant adhesive which will not dissolve or distort. Any splashbacks must be of heat-resistant material.
- ▶ The cooktop must not be installed over a fridge, fridge-freezer, freezer, dishwasher, washing machine, washer-dryer or tumble dryer.
- ▶ After installation, ensure that nothing can come into contact with the connection cable and that it is without hindrance.
- ▶ The connection cable may not come into contact with any moving kitchen component (e.g. a drawer) or be subject to mechanical obstruction which could damage it.
- ▶ Carefully observe the safety clearances listed on the following pages.

Installation

Safety distances

Safety distance above the cooktop

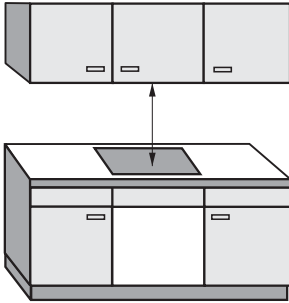

The safety distance specified by the manufacturer of the rangehood must be maintained between the cooktop and the rangehood above it.

If the manufacturer's instructions are not available for the rangehood, a minimum safety distance of 500 mm must be maintained.

For any flammable objects, e.g. utensil rails, wall units etc., a minimum safety distance of 500 mm must be maintained between these objects and the highest part of the cooktop below.

When two or more appliances which have different safety distances are installed together below a rangehood, observe the greatest specified safety distance.

Minimum safety distance underneath the cooktop

To ensure sufficient ventilation to the cooktop, a minimum distance must be left between the underside of the cooktop and any oven, interim shelf or drawer.

The minimum gap between the underside of the cooktop and

- the top edge of an oven: 25 mm
- the top edge of an interim shelf: 25 mm
- the top edge of a drawer: 5 mm
- the base of a drawer: 75 mm

Interim shelf

It is not necessary to fit an interim shelf underneath the cooktop but one may be fitted if you wish.

Side view

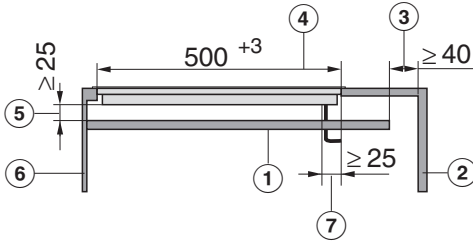

- ① Interim shelf
- ② Cabinet rear wall
- ③ Minimum distance between the rear edge of the interim shelf and the rear cabinet wall for ventilation of the cooktop
- ④ Worktop cut-out
- ⑤ Minimum distance between the underside of the cooktop and the upper edge of the interim shelf for ventilation of the cooktop.
- ⑥ Front
- ⑦ Cut-out for feeding through the mains connection cable
Minimum distance from rear edge of worktop cut-out to edge of interim shelf cut-out

View from above

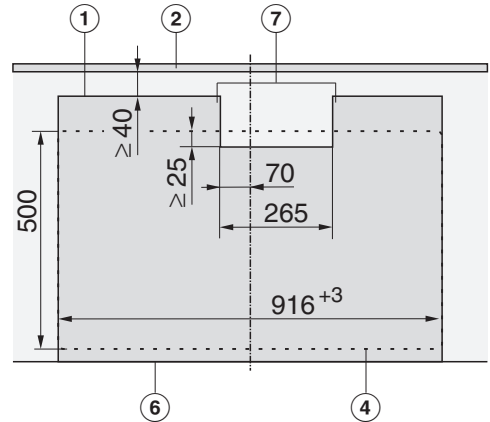

- ① Interim shelf
- ② Cabinet rear wall
- ④ Worktop cut-out
- ⑥ Front
- ⑦ Cut-out for feeding through the mains connection cable
Minimum distance from rear edge of worktop cut-out to edge of interim shelf cut-out

Installation

Safety distances to the sides and back of the appliance

The minimum distance shown below must be maintained between the back edge of the cooktop and a tall unit or wall.

Ideally the cooktop should be installed with plenty of space on either side. There may be a wall at the rear or a tall unit or wall on one side (right or left), taking into account the distances below. On the other side, however, no tall unit or wall should stand closer than 300 mm to the edge of the cooktop. Before installing the cooktop, check that the below clearance requirements are met.

Minimum horizontal distance from the **back edge** of the cooktop to a combustible surface:
50 mm.

Minimum horizontal distance from the **right edge** of the cooktop to a combustible surface:
50 mm.

Minimum horizontal distance from the **left edge** of the cooktop to a combustible surface:
50 mm.

Installation notes – surface-mounted

Seal between the cooktop and the worktop

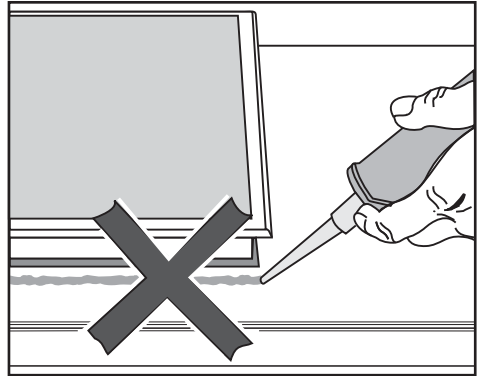

 Damage caused by incorrect installation.

Using sealant under the cooktop could result in damage to the cooktop and the worktop if the cooktop ever needs to be removed for servicing.

Do not use sealant between the cooktop and the worktop.

The sealing strip under the edge of the cooktop provides a sufficient seal for the worktop.

Tiled worktop

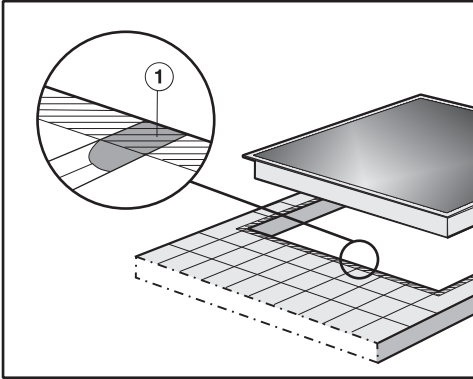

Grout lines ① and the hatched area underneath the cooktop frame must be smooth and even. If they are not, the cooktop will not sit flush with the worktop and the sealing strip underneath the cooktop will not provide a good seal between the cooktop and the worktop.

Sealing strip

Dismantling the cooktop for service purposes may damage the sealing strip underneath the edge of the cooktop.

Always replace the sealing strip before reinstalling the cooktop.

Installation

Installation dimensions – Surface-mounted

All dimensions in this instruction booklet are given in mm.

Installation dimensions – KM 7999 FR

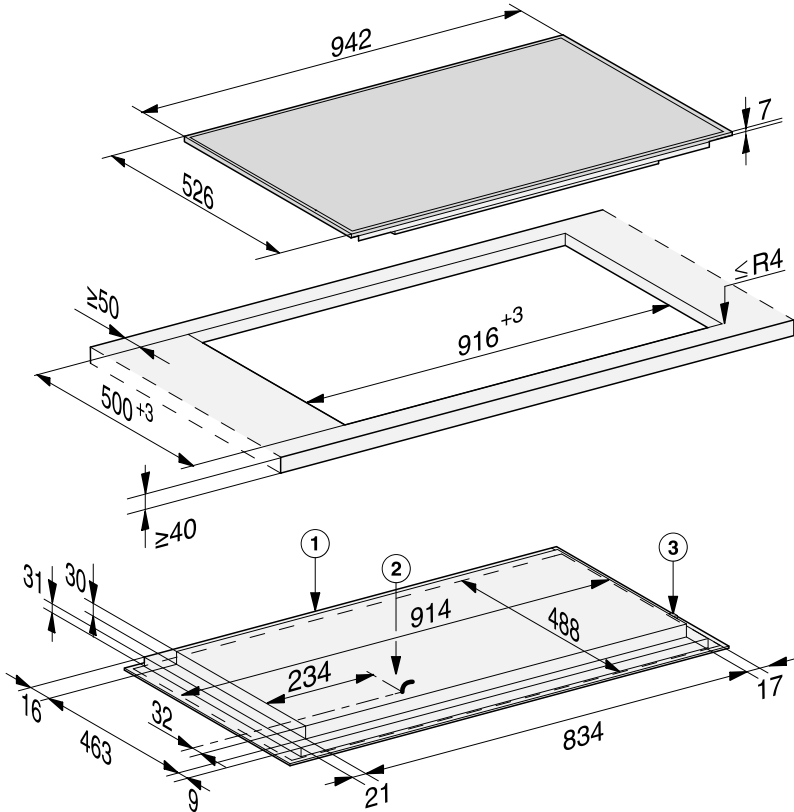

- ① Front
- ② Mains connection box with mains connection cable
Mains connection cable L = 1,280 mm
- ③ Wi-Fi stick connection

Installation dimensions – KM 7999 FL

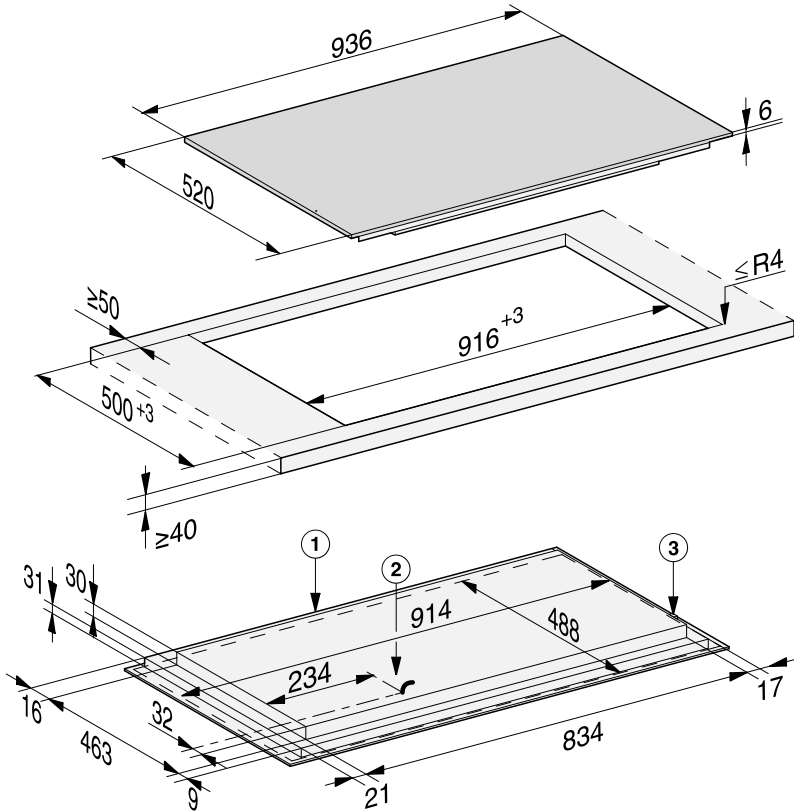

- ① Front
- ② Mains connection box with mains connection cable
Mains connection cable L = 1,280 mm
- ③ Wi-Fi stick connection

Installation

Surface-mounted installation

- Create the worktop cut-out.
Remember to maintain the minimum safety distances (see “Installation – Safety distances”).
- Seal the cut surfaces of **wooden worktops** with a suitable sealant to avoid swelling caused by moisture. The sealant must be heat-resistant.

Make sure the sealant does not come into contact with the top surface of the worktop.

- Attach the sealing strip provided underneath the edge of the cooktop. Do not apply the sealing strip under tension.
- Feed the mains connection cable for the cooktop down through the worktop cut-out.
- Place the cooktop centrally in the cut-out. When doing this, make sure that the seal of the appliance sits flush with the worktop on all sides. This is important to ensure an effective seal with the worktop.

Do not use any additional sealant (e.g. silicone).

If the seal does not meet the worktop correctly on the corners, the corner radius ($\leq R4$) can be carefully scribed to suit.

- Connect the cooktop to the mains electricity supply (see "Installation – Electrical connection").
- Check that the cooktop works.

Installation notes – flush-fit

A flush-fit cooktop is suitable only for installation in natural stone (granite, marble), solid wood and tiled worktops. Certain models are also suitable for building into glass worktops – these are marked with an appropriate note in “Installation – Flush-fit installation”. When using a worktop made from any other material, please check first with the worktop manufacturer that it is suitable for installing a flush-fit cooktop.

The internal width of the base unit underneath the appliance must be at least as wide as the inner worktop cut-out (see “Installation – Installation dimensions – Flush-fit”), so that the cooktop is easily accessible from underneath after installation and the bottom half of the casing can be removed for maintenance. If the underside of the cooktop is not freely accessible after installation, any sealant used to plug the gaps around the appliance must be removed to enable the cooktop to be lifted out of the cut-out should this be necessary.

Natural stone worktops

The cooktop is placed directly in the cut-out.

Solid wood worktops, tiled worktops, glass worktops

The cooktop is placed on a wooden frame inside the cut-out. The frame must be provided on site and is not supplied with the appliance.

Sealing strip

Dismantling the cooktop for service purposes may damage the sealing strip underneath the edge of the cooktop.

Always replace the sealing strip before reinstalling the cooktop.

Installation

Installation dimensions – Flush-fit

All dimensions in this instruction booklet are given in mm.

Installation dimensions – KM 7999 FL

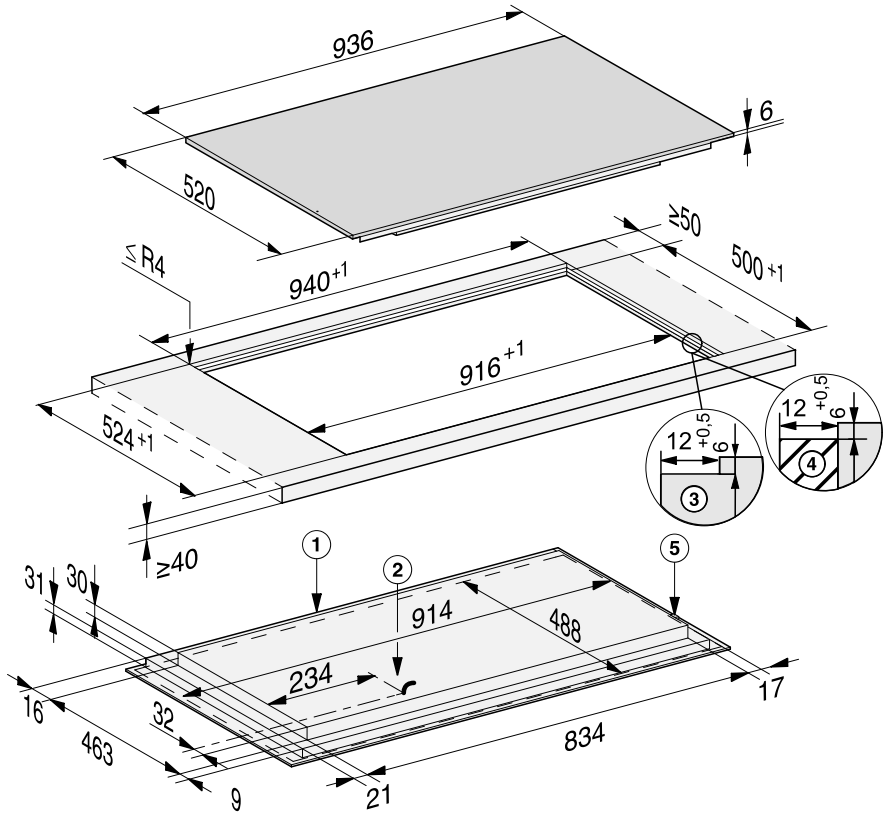

- ① Front
- ② Mains connection box with mains connection cable
Mains connection cable L = 1,280 mm
- ③ Stepped cut-out, natural stone worktop
- ④ Wooden strip 12 mm (not supplied)
- ⑤ Wi-Fi stick connection

Flush-fit installation

- Create the worktop cut-out.
Remember to maintain the minimum safety distances (see "Safety distances").
- Solid wood, tiled and glass worktops:
Fix a wooden frame 6 mm below the top edge of the worktop (see "Installation dimensions - Flush").
- Attach the sealing strip provided underneath the edge of the cooktop.
Do not apply the sealing strip under tension.
- Feed the mains connection cable down through the worktop cut-out.
- Centre the cooktop in the cut-out.

The gap between the ceramic surface and the worktop must be at least 2 mm wide. This is required so that the cooktop can be sealed.

- Connect the cooktop to the mains electricity supply (see "Installation – Electrical connection").
- Check that the cooktop works.
- Seal the gap between the cooktop and worktop with a silicone sealant that is heat-resistant to at least 160 °C.

 **Damage caused by unsuitable sealant.**

Unsuitable sealant can damage natural stone.

For natural stone worktops and natural stone tiles, only use silicone sealant that is specially formulated for natural stone. Please follow the manufacturer's instructions.

Installation

Electrical connection

 Risk of damage from incorrect connection.

Incorrect installation, maintenance and repairs can be dangerous to users.

Miele cannot be held liable for damage or injury caused by incorrect or unauthorised installation, maintenance or repair work, or by an inadequate or faulty on-site earthing system (e.g. electric shock).

All electrical work must be carried out by a suitably qualified and competent electrician, in strict accordance with current national and local safety regulations, and any additional regulations of the local electricity provider.

After installation, ensure that all electrical components are shielded and cannot be accessed by users.

Total power output

See data plate.

Connection data

The connection data is quoted on the data plate. Please ensure this information matches the household mains supply.

Please see the wiring diagrams for connection.

Residual current device

For extra safety, it is advisable to protect the appliance with a suitable residual current device (RCD) with a trip range of 30 mA.

Disconnecting devices

Connection must be made via a suitable isolator switch which provides disconnection on all poles and which complies with national and local safety regulations. When switched off there must be an all-pole contact gap of at least 3 mm in the isolator switch. The isolator switch must be easily accessible after the appliance has been built in.

Disconnecting from the mains

The cooktop's mains electrical connection must be accessible in case there is a need for servicing or repairs.

Ensure compliance with national regulations and any additional regulations issued by the local electricity provider.

Wiring diagram AC 220-240 V

Under adverse conditions of the power supply network this device can cause irritating voltage fluctuations in single phase connection. If the network impedance at the point of coupling to the public supply network is higher than 0.31Ω , additional measures may be required to avoid these irritations. If necessary, information about the impedance can be inquired at the local distribution network operator.

Mains connection cable

The cooktop must be connected to the electrical supply with a special connection cable with a suitable diameter. Please see the wiring diagram for connection. The connection cable comes supplied with ferrite sleeves attached. If using a different connection cable the power cable must be fed through the opening of the ferrite sleeves before attaching them to the connection terminals.

Wiring diagram

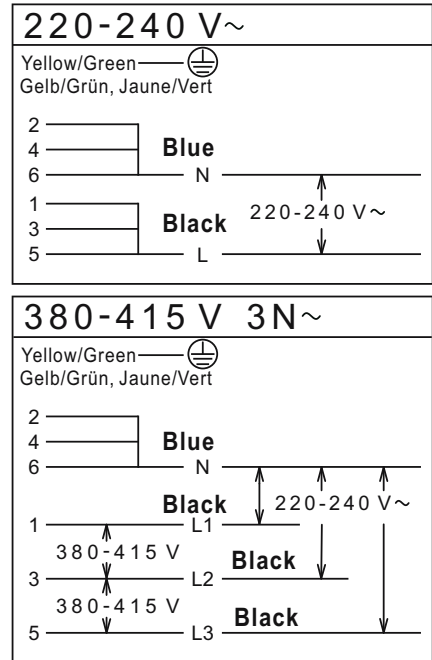

Miele Australia Pty. Ltd.

ACN 005 635 398
ABN 96 005 635 398

Miele Head Office Melbourne:

Level 4, 141 Camberwell Road
Hawthorn East, VIC 3123

Miele Experience Centre Doncaster:

1136/7 Doncaster Shopping Centre
619 Doncaster Rd, Doncaster, VIC 3108

Miele Experience Centre South Melbourne:

206-210 Coventry Street
South Melbourne, VIC 3205

Miele Experience Centre and Office Sydney:

3 Skyline Place
Frenchs Forest, NSW 2086

Miele Experience Centre and Office Brisbane:

Tenancy 4C, 63 Skyring Terrace
Newstead, QLD 4006

Miele Experience Centre Gold Coast:

131 Ferry Road
Southport, QLD 4215

Miele Experience Centre and Office Adelaide:

83-85 Sir Donald Bradman Drive
Hilton, SA 5033

Miele Experience Centre and Office Perth:

205-207 Stirling Highway
Claremont, WA 6010

1300 464 353 (1300 4 MIELE)

www.miele.com.au

Miele New Zealand Limited

IRD 98 463 631

**Miele Experience Centre
and Head Office Auckland:**

8 College Hill
Freemans Bay, Auckland 1011

**Miele Experience Centre
Wellington:**

183 Featherston Street
Wellington 6011

0800 464 353 (0800 4 MIELE)

www.miele.co.nz

**Miele Global Headquarters
Germany**

Miele & Cie. KG

Carl-Miele-Straße 29
33332 Gütersloh
Federal Republic of Germany

KM 7999 FR, KM 7999 FL

en-AU, NZ

M.-Nr. 11 373 090 / 02